

SHELVES

presentanova®

WS.2024



QUADRO shelves	2
AURA shelves	10
VERA shelves	16
VIVIDA shelves	20
POLAR shelves	22
UNILOCK shelves	26
DIVERSE system	32
STRIPE system	38
WORK WITH US	44
SHOP DESIGN	44
PRODUCTION	44
SHOWROOM	45

QUADRO

Shelf height defines the product family: Bold or Slim.

Every shelf is magnetic (bottom and front) and comes with integrated white LED lighting.

Shelves are also available with integrated lockable frame holders (Single Lock system) or with sliding acrylic doors (Quadro Slim Lockable).

Bold and Slim displays can come with Dual back storage.



WS.Q
WM

SHELVES



QUADRO BOLD displays

QUADRO BOLD

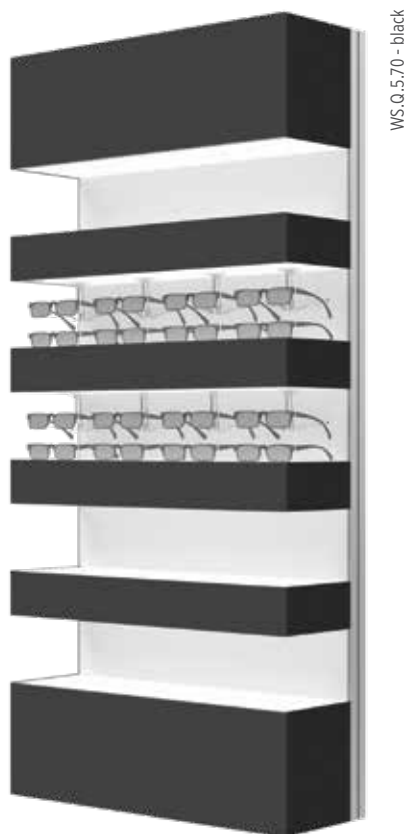

QUADRO BOLD SINGLE LOCK

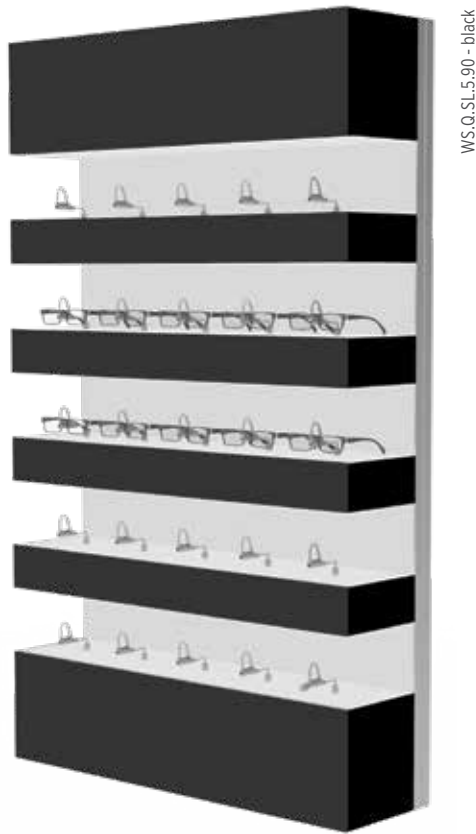

Magnetic frame holder
A.S.MGH1

11,00 €



Magnetic-coded key locks every
frame separately.
A.SL.MK

13,00 €



Display with 5 acrylic LED shelves. Shelves have magnetic front and bottom.

900x1500x280 mm	WS.Q.5.90	2.144,00 €
700x1500x280 mm	WS.Q.5.70	1.930,00 €

Display with 5 acrylic LED shelves and lockable frame holders. Shelves have magnetic front and bottom.

900x1500x280 mm / 25 ∅	WS.Q.SL.5.90	2.617,00 €
700x1500x280 mm / 20 ∅	WS.Q.SL.5.70	2.308,00 €

QUADRO SLIM displays

QUADRO SLIM



WS.QS.5.90 - black

QUADRO SLIM SINGLE LOCK

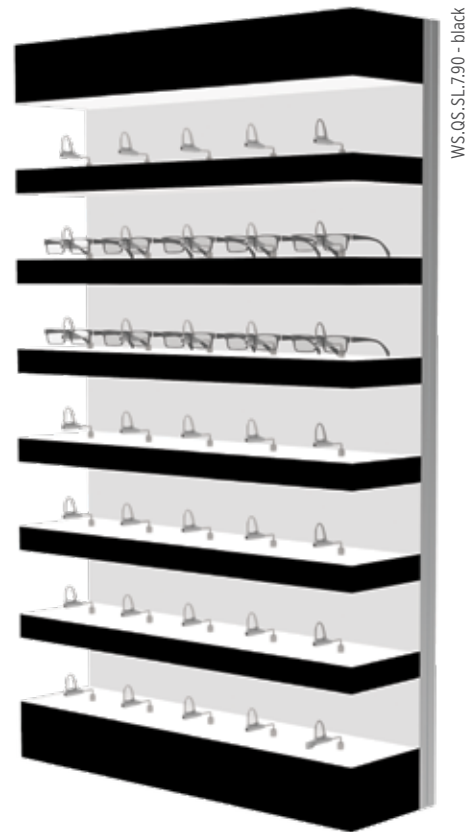

WS.QS.SL.7.90 - black



Decorative magnetic masks for shelves.



Magnetic-coded key locks every frame separately.
A.SL.MK 13,00 €

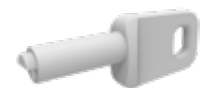

Display with 7 acrylic LED shelves. Shelves have magnetic front and bottom.

900x1500x280 mm	WS.QS.7.90	2.264,00 €
700x1500x280 mm	WS.QS.7.70	2.037,00 €

Display with 7 acrylic LED shelves and lockable frame holders. Shelves have magnetic front and bottom.

900x1500x280 mm/35 ∅	WS.QS.SL.7.90	2.925,00 €
700x1500x280 mm/28 ∅	WS.QS.SL.7.70	2.566,00 €

QUADRO SLIM lockable display

QUADRO SLIM with lockable doors



WS.QS.L.7.90 - black



Sliding acrylic doors are opened with a magnetic-coded key. Every shelf door is opened separately. Magnetic key lock for every shelf is carefully hidden behind the shelf front.

A.QS.MK

42,00 €



Display with 7 acrylic LED shelves and acrylic doors. Shelves have magnetic bottom and front side. Doors for every shelf are opened separately by sliding to the left/right. 1 magnetic-coded key is included in the price.

900x1500x280 mm
Magnetic-coded key

WS.QS.L.7.90
A.QS.MK

3.311,00 €
42,00 €



Silhouette®



QUADRO accessories

1



1

Magnetic frame holders.
Rotating and movable.
A.S.MGH1 / acrylic 11,00 €
A.S.MGH2 / aluminium 11,00 €

2

2

Hanging sliding mirror.
A.Q.M / Bold 446,00 €
A.QS.M / Slim / Diverse 446,00 €

3

3

Small acrylic shelf mirror.
A.Q.MS / Bold 44,00 €
A.QS.MS / Slim / Diverse 44,00 €



4

Magnetic acrylic logo holder.
Print included. 140x65 mm
A.Q.MLH 18,00 €

5

Decorative front cover is magnetically attached to the shelf front. This feature allows quick changes in display design. Different colours and decors available.

BOLD

A.Q1.MC.90 38,00 €
100x900 mm
A.Q1.MC.70 29,00 €
100x700 mm
A.Q2.MC.90 57,00 €
200x900 mm
A.Q2.MC.70 44,00 €
200x700 mm

SLIM / DIVERSE

A.QSD1.MC.110 27,00 €
50x1100 mm
A.QSD1.MC.90 22,00 €
50x900 mm
A.QSD1.MC.70 17,00 €
50x700 mm
A.QSD2.MC.110 46,00 €
100x1100 mm
A.QSD2.MC.90 38,00 €
100x900 mm
A.QSD2.MC.70 29,00 €
100x700 mm

4

5



Magnetic

6

Quadro LED light box with removable magnetic front. Standard colours are black and white. Other decors available on request.

6

A.Q.AB.90 305,00 €
900x500x280 mm
A.Q.AB.70 273,00 €
700x500x280 mm

LED light box without and with the magnetic front.



Magnetic

Magnetic

Exchangeable magnetic front for Quadro LED light box.
A.Q.AF.90 116,00 €
900x500 mm
A.Q.AF.70 104,00 €
700x500 mm

AURA

Create a unique atmospheric display lighting within your shop!

Subtle white LED lighting mixes with coloured LED lighting for an outstanding effect.

Shelves come with magnetic bottom that allows great creativity and flexibility in displaying your eyewear.

Aura displays are available with Dual storage.



WS.AU

SHELVES



AURA displays

AURA



WS.AU.7.90

AURA R

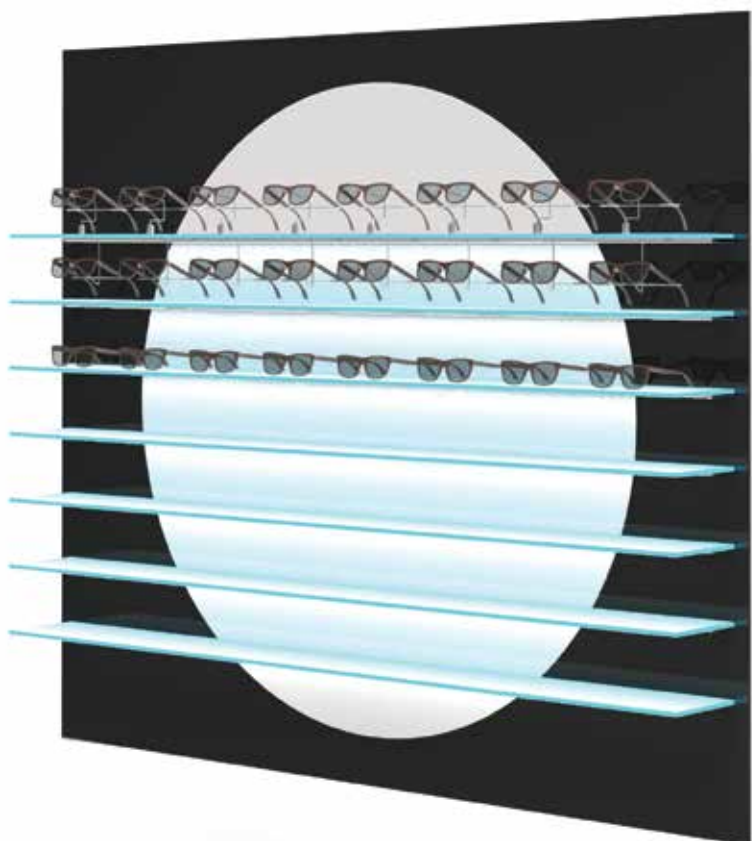

WS.AUR.1.7.180 - black acrylic

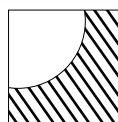

1
Inner circle in white acrylic. Various decors available for the deco frame.

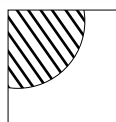

2
Decorative frame in white acrylic. Various decors available for the inner circle.

Inner circle and decorative frame come in standard white or black acrylic. Both can also come in various decors (version 1 and 2).

Display with acrylic LED shelves with magnetic bottom. Integrated white and RGB LED lighting.

900x1500x280 mm / 7 shelves	WS.AU.7.90	2.163,00 €
700x1500x280 mm / 7 shelves	WS.AU.7.70	1.847,00 €
450x1500x280 mm / 7 shelves	WS.AU.7.45	1.578,00 €

900x1500x280 mm / 10 shelves	WS.AU.10.90	2.478,00 €
700x1500x280 mm / 10 shelves	WS.AU.10.70	2.162,00 €
450x1500x280 mm / 10 shelves	WS.AU.10.45	1.893,00 €

Display with 7 acrylic LED shelves and decorative acrylic frame. Shelves have magnetic bottom. Integrated white and RGB LED lighting.

1800x1500x280 mm	WS.AUR.1.7.180	4.391,00 €
white circle	WS.AUR.2.7.180	4.391,00 €
white decorative frame		

AURA accessories



1

1
Magnetic frame holders.
Rotating and movable.
A.S.MGH1 / acrylic 11,00 €
A.S.MGH2 / aluminium 11,00 €

2
Acrylic logo holder with exchangeable graphics.
A.AU.LH 130x60 mm 9,50 €

3
Sliding advertisement, print included.
A.AU.AP 385x438 mm 23,00 €

4
Decorative frame with magnetically exchangeable logo front.
A.AU.DF1 205x438 mm 24,00 €
A.AU.DF2 385x438 mm 36,00 €

Magnetic logo front, print included.
A.AU.DFM1 205 mm 9,50 €
A.AU.DFM2 385 mm 9,50 €

5
Sliding mirror with decorative frame.
A.AU.M 205x438 mm 36,00 €



2

3

4



5





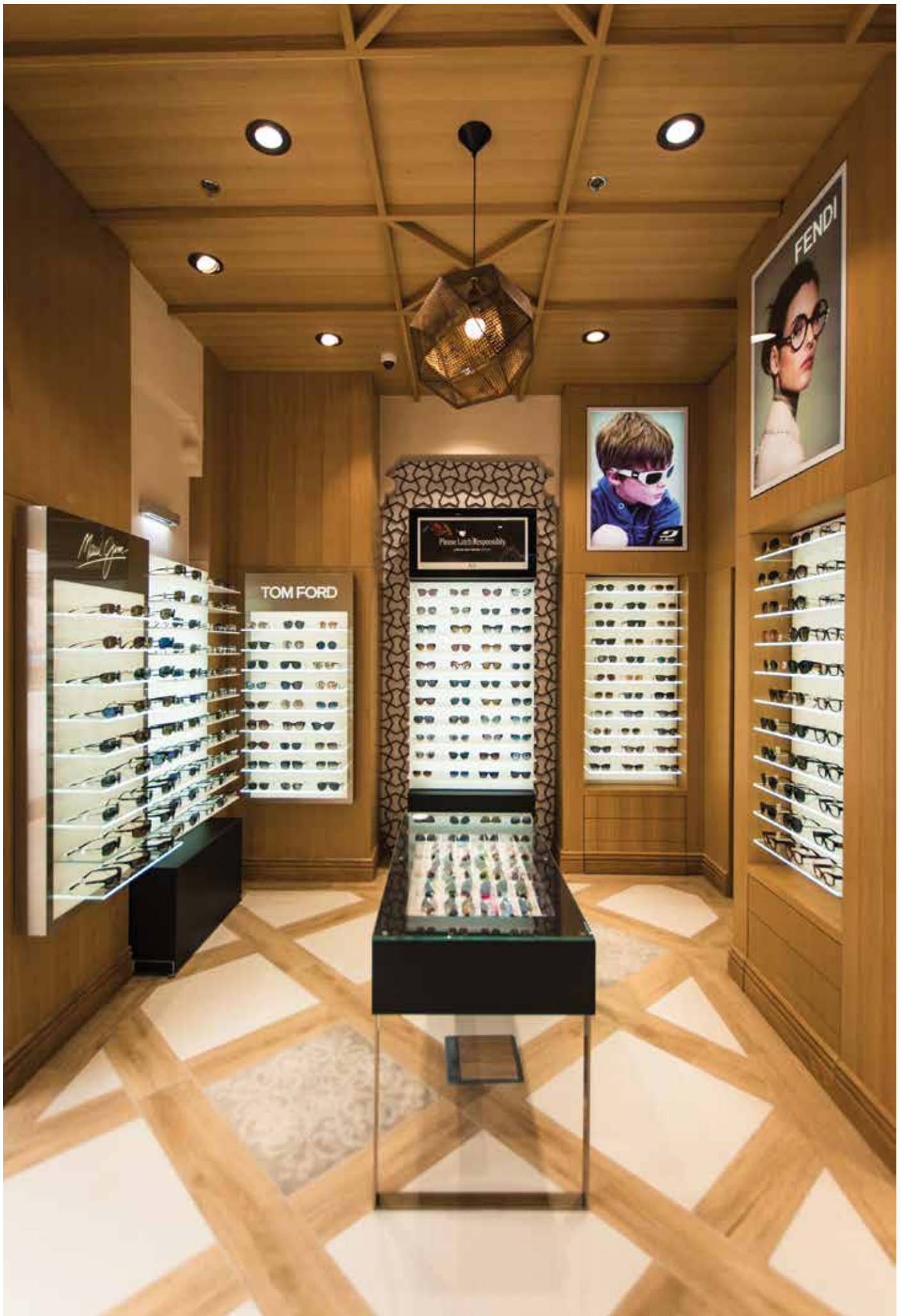

VERA

Multipurpose glass shelves — perfect for displaying various merchandise, from standard eyewear up to contact lenses and solutions.

Glass shelves come in clear transparent version or with engravings to further highlight your eyewear and to ease the stocktaking process.

Integrated white or coloured edge LED lighting.



WS.VE

SHELVES



VERA displays

VERA with 7 shelves

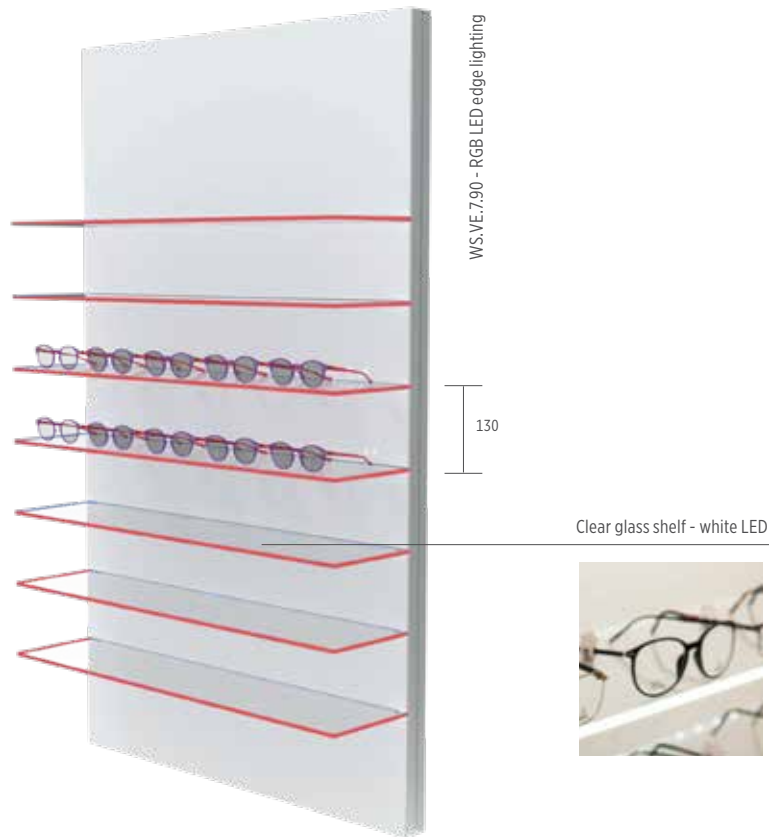

VERA with 4 shelves



7 glass shelves with edge lighting in white or RGB LED - please define at order.
Custom engraving available upon request. All engravings are lit.

900x1500x280 mm	WS.VE.7.90	1.664,00 €
700x1500x280 mm	WS.VE.7.70	1.461,00 €
450x1500x280 mm	WS.VE.7.45	1.256,00 €

4 glass shelves with edge lighting in white or RGB LED - please define at order.

900x1500x280 mm	WS.VE.4.90	1.590,00 €
700x1500x280 mm	WS.VE.4.70	1.385,00 €
450x1500x280 mm	WS.VE.4.45	1.218,00 €

VERA accessories



1

VE1.90
top view



VE2.90
top view



2



3



4



5



1

Glass shelf with engraved fields.
VE1.90 900 mm / 5 engraved fields 250,00 €
VE1.70 700 mm / 4 engraved fields 221,00 €
VE1.45 450 mm / 2 engraved fields 192,00 €

Glass shelf with engraved stripe.
VE2.90 900 mm 250,00 €
VE2.70 700 mm 221,00 €
VE2.45 450 mm 192,00 €

2

Acrylic logo holder with exchangeable graphics.
A.VE.LH 130x60 mm 9,50 €

3

Sliding advertisement, print included.
A.VE.AP 385x438 mm 23,00 €

4

Decorative frame with magnetically exchangeable logo front.
A.VE.DF1 205x438 mm 24,00 €
A.VE.DF2 385x438 mm 36,00 €

Magnetic logo front, print included.

A.VE.DFM1 205 mm 9,50 €
A.VE.DFM2 385 mm 9,50 €

5

Sliding mirror with decorative frame.
A.VE.M 205x438 mm 36,00 €



Exchangeable magnetic fronts allow easy changes in panel design. Standard panel is in glossy white acrylic. Other decors on request.

VIVIDA SHELVES

Vivida acrylic shelves contain ambiental white shelf LED lighting and decorative edge lighting.

Edge lighting provides a modern touch and you can choose between plain white LED and coloured RGB LED lighting.

Vivida display can come with Dual back storage.



WS.VD

VIVIDA displays

VIVIDA



WS.VD.7.70 - RGB LED edge lighting

White LED edge lighting



RGB LED edge lighting



VIVIDA

Display with acrylic LED shelves. Beside ambient white shelf lighting, every shelf has decorative edge lighting — white or RGB — please define at order.

900x1500x280 mm / 7 shelves	WS.VD.7.90	2.418,00 €
700x1500x280 mm / 7 shelves	WS.VD.7.70	2.102,00 €
450x1500x280 mm / 7 shelves	WS.VD.7.45	1.833,00 €
900x1500x280 mm / 10 shelves	WS.VD.10.90	2.733,00 €
700x1500x280 mm / 10 shelves	WS.VD.10.70	2.417,00 €
450x1500x280 mm / 10 shelves	WS.VD.10.45	2.148,00 €

VIVIDA SINGLE LOCK

Display with acrylic LED shelves and lockable frame holders. Beside ambient white shelf lighting, every shelf has decorative edge lighting — white or RGB — please define at order. 1 magnetic-coded key included in the price.

7 SHELVES		
900x1500x280 mm / 35 ☉	WS.VD.SL.7.90	3.080,00 €
700x1500x280 mm / 28 ☉	WS.VD.SL.7.70	2.631,00 €
450x1500x280 mm / 14 ☉	WS.VD.SL.7.45	2.098,00 €
10 SHELVES		
900x1500x280 mm / 50 ☉	WS.VD.SL.10.90	3.080,00 €
700x1500x280 mm / 40 ☉	WS.VD.SL.10.70	2.631,00 €
450x1500x280 mm / 20 ☉	WS.VD.SL.10.45	2.098,00 €



A.SL.MK 13,00 €



POLAR

Polar shelves are lit from behind – the entire back panel works as a large light box.

Imagine every detail of your eyeglasses beautifully highlighted.

Ideal solution for contemporary interiors that crave incredibly bright lighting.



WS.PO

SHELVES



POLAR displays

POLAR



WS.PO.790



Display with 7 acrylic shelves. Integrated white LED back panel.

900x1500x280 mm / 7 shelves	WS.PO.790	1.790,00 €
700x1500x280 mm / 7 shelves	WS.PO.770	1.558,00 €
450x1500x280 mm / 7 shelves	WS.PO.745	1.327,00 €

POLAR accessories



1

1
Acrylic logo holder with exchangeable graphics.
A.PO.LH 130x60 mm 9,50 €

2
Sliding advertisement, print included.
A.PO.AP 385x438 mm 23,00 €

3
Decorative frame with magnetically exchangeable logo front.
A.PO.DF1 205x438 mm 24,00 €
A.PO.DF2 385x438 mm 36,00 €

Magnetic logo front, print included.
A.PO.DFM1 205 mm 9,50 €
A.PO.DFM2 385 mm 9,50 €

4
Sliding mirror with decorative frame.
A.PO.M 205x438 mm 36,00 €



2

3



4



UNILOCK

Anti-theft shelf with lockable frame holders.

Patented locking system allows simultaneous locking and unlocking of all frame holders on 1 shelf.

Shelf is available in several standard and also custom sizes.

Unilock display is available with Dual storage.



WS.UJ

SHELVES



UNILOCK displays

UNILOCK with 7 shelves

Optional with Dual back storage cabinet.



WS.ULE.7.70



Display with LED acrylic shelves with integrated magnetic-coded key locks. Magnetic-coded key locks/unlocks all frame holders in the same shelf simultaneously. 1 magnetic-coded key included in price.

7 shelves		
900x1500x280 mm / 35 ∅	WS.ULE.7.90	2.972,00 €
700x1500x280 mm / 28 ∅	WS.ULE.7.70	2.230,00 €
450x1500x280 mm / 14 ∅	WS.ULE.7.45	1.772,00 €

10 shelves		
900x1500x280 mm / 50 ∅	WS.ULE.10.90	3.576,30 €
700x1500x280 mm / 40 ∅	WS.ULE.10.70	2.576,70 €
450x1500x280 mm / 20 ∅	WS.ULE.10.45	2.065,35 €



Simple magnetic-coded key is universal for all shelves.

UNILOCK accessories



1

1
Adapter for small eyewear. Reduces the space inside the hook and secures the frames.
A.U.L.ADP 2,10 €



2

2
Acrylic logo holder with exchangeable graphics. Available only with UniLock displays, not UniLock shelves.
A.U.L.LH1 130x60 mm 9,50 €



3

3
Sliding shelf advertisement, print included. Available only with UniLock displays, not UniLock shelves.
A.U.L.AP 385x438 mm 23,00 €



4

4
Decorative frame with magnetically exchangeable logo front. Available only with UniLock displays, not UniLock shelves.
A.U.L.DF1 205x438 mm 24,00 €
A.U.L.DF2 385x438 mm 36,00 €

Magnetic logo front, print included.
A.U.L.DFM1 205 mm 9,50 €
A.U.L.DFM2 385 mm 9,50 €



5



5
Sliding mirror with decorative frame. Available only with UniLock displays, not UniLock shelves.
A.U.L.M 205x438 mm 23,00 €



UNILOCK system

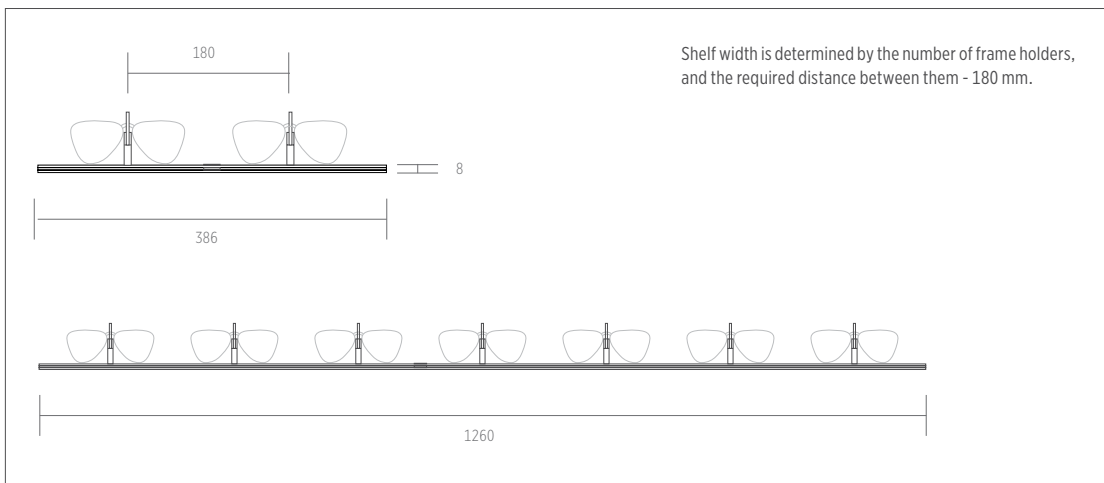

SHELF

Incredibly thin (8 mm), Unilock shelf in white acrylic comes with patented locking mechanism - magnetic coded. Mechanism simultaneously locks/unlocks all frame holders on 1 shelf. Standard shelf can support 2-7 frame holders. Custom sizes available on request.

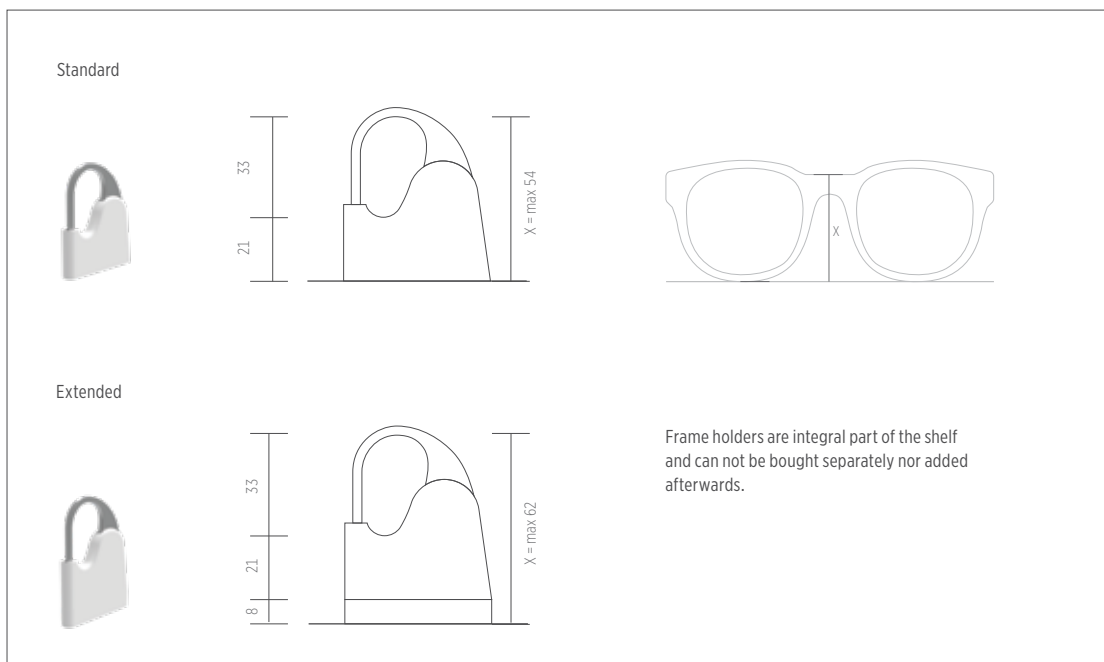

FRAME HOLDER

We provide 2 types of lockable frame holders; standard and extended - with an adapter for extremely large eyewear. It is possible to combine both holders on 1 shelf (on request). Polycarbonate, aluminium.



MAGNETIC-CODED KEY

Magnetic-coded key is placed on the magnetic surface to activate the locking system. Push on the button locks/unlocks the frame holders.

UNILOCK shelves

1

Standard shelves. Custom sizes on request.

UL.2

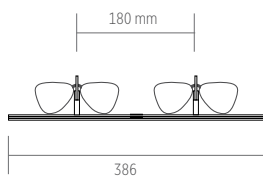

UL.3

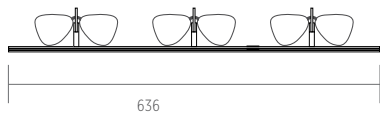

UL.4

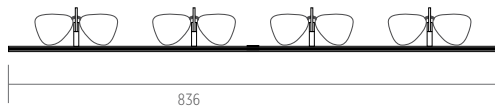

UL.5

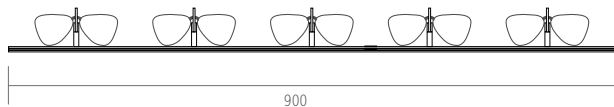

UL.6

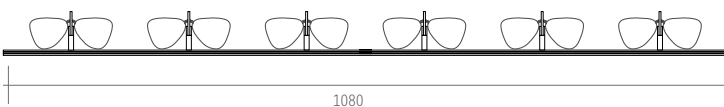

UL.7

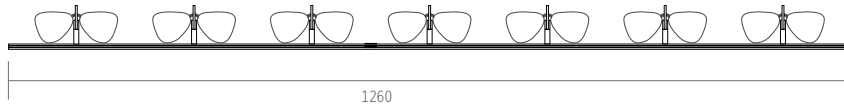

Simple installation onto existing shelves!
For more information contact us at:
info@presenta-nova.hr

1

Only 8 mm thick, the shelf can support 2-7 lockable frame holders. Shelf is available with 2 types of frame holders: classic and extended (for large eyewear). Shelf width is determined by the number of frame holders, and the required distance between them which is 180 mm. Custom sizes available on request.

Standard frame holders

UL.S.2	386x187x8 mm / 2	98,00 €
UL.S.3	636x187x8 mm / 3	116,00 €
UL.S.4	836x187x8 mm / 4	146,00 €
UL.S.5	900x187x8 mm / 5	171,00 €
UL.S.6	1080x187x8 mm / 6	189,00 €
UL.S.7	1260x187x8 mm / 7	202,00 €

Extended frame holders

UL.EX.S.2	386x187x8 mm / 2	101,00 €
UL.EX.S.3	636x187x8 mm / 3	121,00 €
UL.EX.S.4	836x187x8 mm / 4	152,00 €
UL.EX.S.5	900x187x8 mm / 5	179,00 €
UL.EX.S.6	1080x187x8 mm / 6	197,00 €
UL.EX.S.7	1260x187x8 mm / 7	211,00 €

2

Magnetic-coded key.
Unlocks/locks all frame holders on 1 shelf simultaneously.

A.UL.MK	42,00 €
---------	---------

2



DIVERSE

System consists of a wall panel and shelves of different sizes.

Every shelf is magnetic (bottom and front) and comes with integrated LED lighting.

Shelves are available with integrated lockable frame holders (Single Lock).

Shelves can not be bought as single units.



W.QD

SYSTEM



DIVERSE combination

DIVERSE

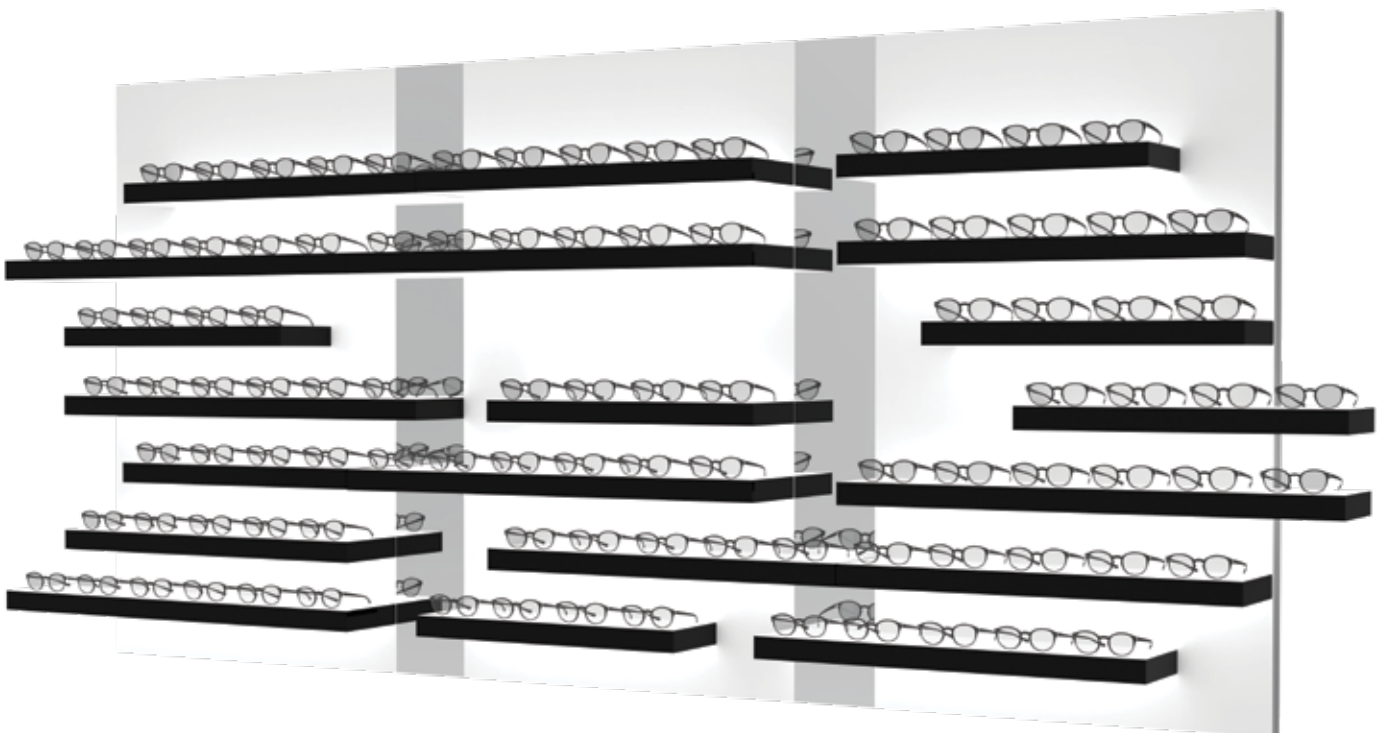

3500

3 x WS.P.QSD.90 / wall panel / white	900x1500 mm	3 x 523,00 €	1.569,00 €
6 x QSD.110 / LED shelf / black	1100x50 mm	6 x 351,00 €	2.106,00 €
7 x QSD.90 / LED shelf / black	900x50 mm	7 x 328,00 €	2.296,00 €
7 x QSD.70 / LED shelf / black	700x50 mm	7 x 316,00 €	2.212,00 €
2 x WM.20.150 / wall mirror	200x1500 mm	2 x 293,00 €	586,00 €

For more combinations please contact us.



DIVERSE system

SYSTEM

SHELVES

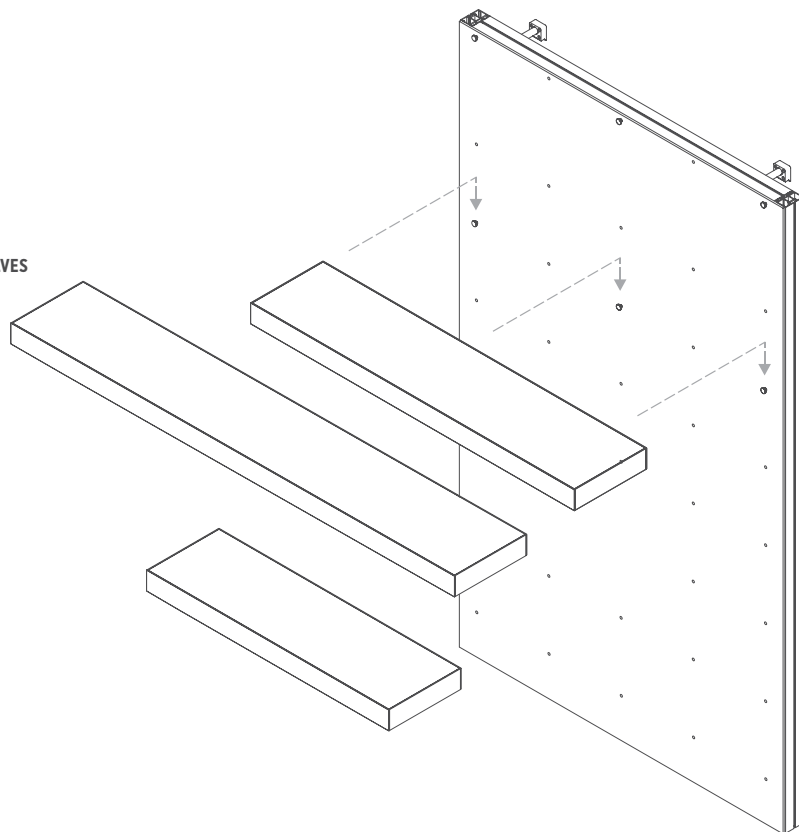

PANEL
WS.P.QSD.90(70)

Various shelving combinations possible.
For more unique combinations please contact us.

1 / 7 shelves

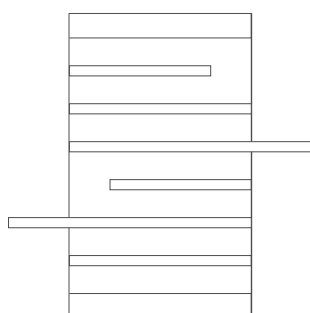

2 / 7 shelves

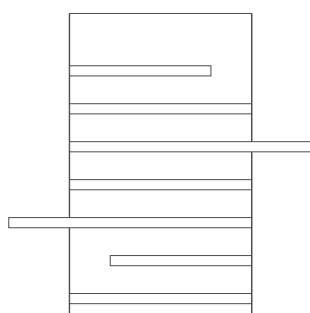

3 / 6 shelves

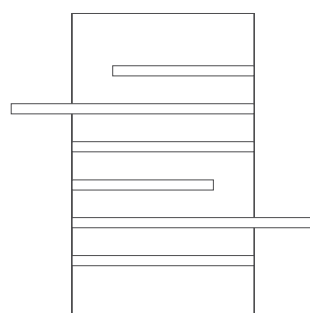

PANEL

Acrylic wall panel has predefined holes with mounting screws which also work as electricity conductors. They provide white LED lighting for every mounted shelf. Panel is compatible with our standard wall add-on elements such as mirrors.

Panel for Diverse shelves

WS.P.QSD.90	523,00 €
900x1500 mm	
WS.P.QSD.70	408,00 €
700x1500 mm	

Panel screws for shelf mount.

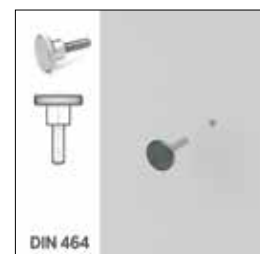

DIVERSE system

SHELVES

Combine various sizes and types of shelves for a unique display. For professional design advice please contact us.

DIVERSE

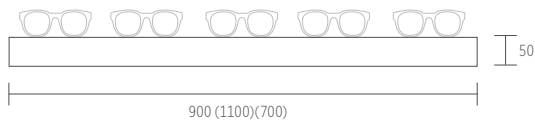

DIVERSE SINGLE LOCK

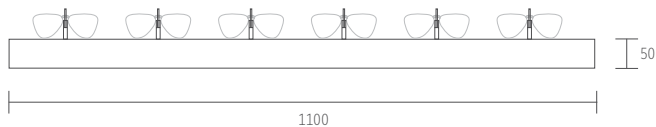
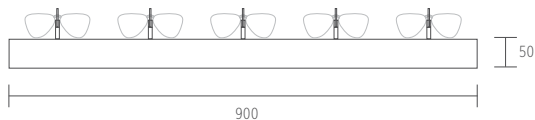
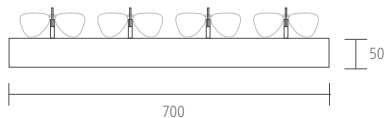

INSTALLATION

Shelf has holes on the back. They allow easy mount on the panel screws.

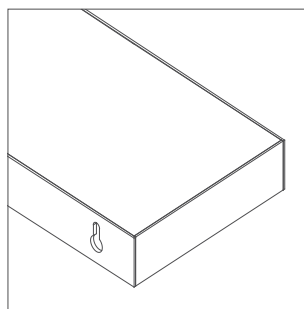

DECOR



Black and white are standard colours.
Other decors available upon request.

SHELF

Acrylic shelf has holes on the back for an easy mount on the panel screws. Once mounted, shelf receives white LED lighting. Shelf has magnetic bottom and front and comes in 3 widths. It can contain lockable frame holders. Standard colours are black and white. Other decors on request. Shelf can not be bought separately.

DIVERSE

QSD.110	1100x50 mm / 6	351,00 €
QSD.90	900x50 mm / 5	328,00 €
QSD.70	700x50 mm / 4	316,00 €

DIVERSE SINGLE LOCK

QSD.SL.110	1100x50 mm / 6	464,00 €
QSD.SL.90	900x50 mm / 5	403,00 €
QSD.SL.70	700x50 mm / 4	373,00 €

Magnetic-coded key		
A.SL.MK		13,00 €

STRIPE

Ideal eye-catching system both for small and large interiors.

Floating shelves are mounted on fronts of various sizes and positions.

Every shelf is lit and with magnetic features.

Custom decor available on request.



W.ST

SYSTEM



STRIPE displays

W.ST3



W.ST4

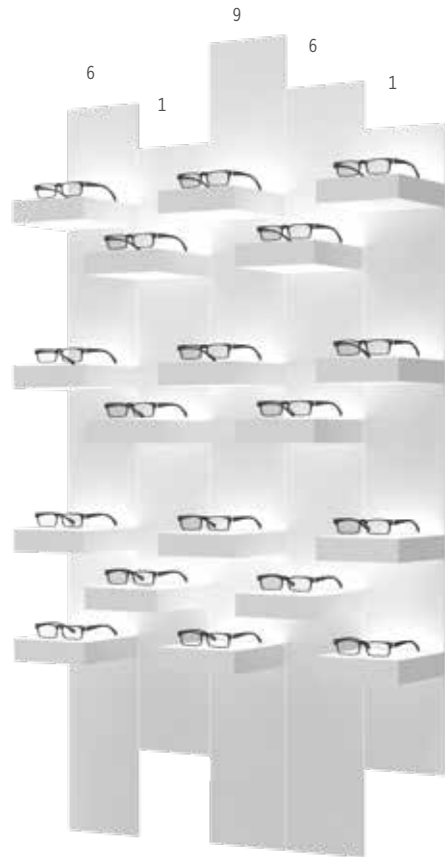

1000x2000 mm

Aluminium frame			
1 x W.P.ST.60	600x1500 mm	1 x 63,00 €	63,00 €
Fronts			
1 x W.F.ST.1 / white	1500x200 mm	1 x 95,00 €	95,00 €
1 x W.F.ST.3 / white	1750x200 mm	1 x 95,00 €	95,00 €
1 x W.F.ST.9 / white	2000x200 mm	1 x 95,00 €	95,00 €
Side masks			
2x W.M.ST.20	1625x200 mm	1 x 92,00 €	92,00 €
LED shelves			
16 x ST.S.20 / white	200x200 mm	16 x 128,00 €	2.048,00 €

1000x2000 mm

Aluminium frame			
1 x W.P.ST.100	1000x1500 mm	1 x 105,00 €	105,00 €
Fronts			
2 x W.F.ST.6 / white	1875x200 mm	1 x 95,00 €	95,00 €
2 x W.F.ST.1 / white	1500x200 mm	2 x 95,00 €	190,00 €
1 x W.F.ST.9 / white	2000x200 mm	1 x 95,00 €	95,00 €
LED shelves			
18 x ST.S.20 / white	200x200 mm	18 x 128,00 €	2.304,00 €



STRIPE system

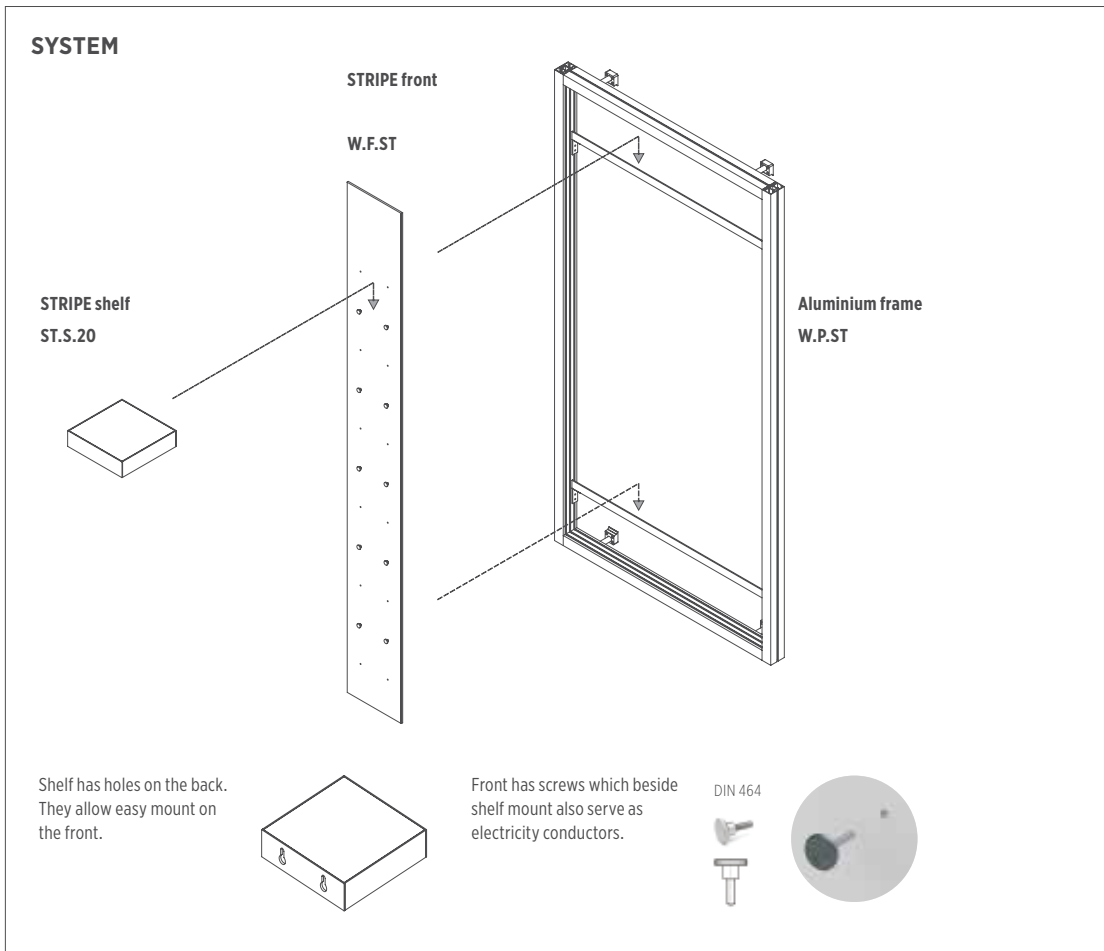

SYSTEM

Acrylic fronts are mounted on a simple aluminium frame in various combinations. Display elements (shelf eg.) are mounted on the fronts, and come with integrated white LED lighting.

Aluminium frame	
W.P.ST.60	63,00 €
W.P.ST.80	84,00 €
W.P.ST.100	105,00 €

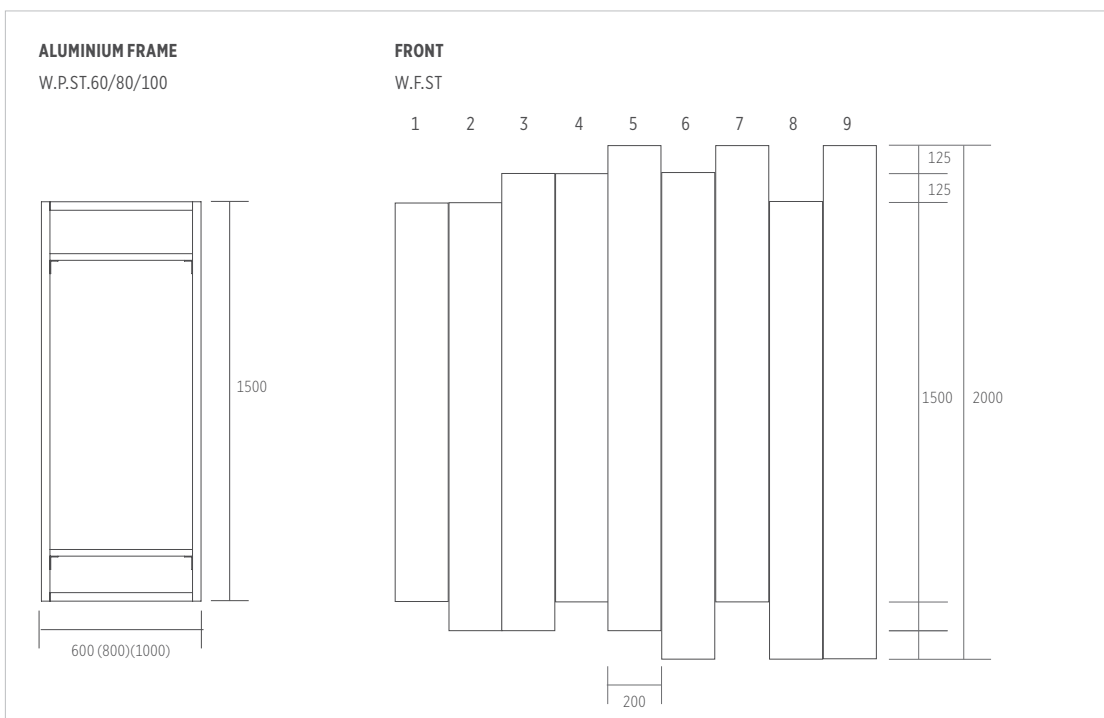

FRAMES & FRONTS









Wall mounted aluminium frame supports fronts and shelves. It comes in 3 standard sizes.

Acrylic front is installed onto the frame. It is 200 mm wide while its height and position on the frame vary (1-9 positions).

Every front has mounting holes with screws for shelves and other display elements. Front is available in different decors.

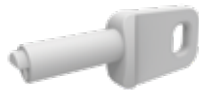
Fronts	
W.F.ST(1-9)	95,00 €
Side mask	
W.M.ST.20.150	92,00 €

STRIPE elements

1	2	<p>1 Floating LED shelf, magnetic front and bottom. ST.S.20 200x200 mm 128,00 €</p>
	 	<p>2 Floating LED shelf with integrated lockable frame holder. Magnetic front and bottom. ST.S.SL.20 200x200 mm 147,00 €</p> <p>Magnetic-coded key. A.SL.MK 13,00 €</p>
3	4	<p>3 LED acrylic box with open front side. ST.LB.20 200x200 mm 181,00 €</p> <p>4 LED acrylic box with open front side and lockable frame holder. ST.LB.SL.20 200x200 mm 201,00 €</p> <p>Magnetic-coded key. A.SL.MK 13,00 €</p>
	 	<p>5 LED advertising element mit magnetically removable acrylic plate. Exchangeable graphics. ST.A.20 200x200 mm 141,00 €</p>
5	6	<p>6 LED logo holder with removable magnetic front. ST.LH 200x200 mm 141,00 €</p> <p>Magnetic logo front with print. ST.LHA 200x200 mm 42,00 €</p>
	 	<p>7 Magnetic acrylic logo holder, print included. A.Q.MLH 140x65 mm 18,00 €</p> <p>8 Acrylic mirror. ST.M.20 200x200 mm 29,00 €</p> <p>9 Magnetic frame holder, sliding and movable. A.S.MGH1 11,00 € A.S.MGH2 11,00 €</p>
10		<p>10 Decorative front cover is magnetically attached to the shelf front. This feature allows quick changes in display design. Different colours and decors available. ST.S.CO 200x50 mm 11,00 €</p>

WORK WITH US

SHOP DESIGN

	Checklist	Space plan design	3D visualizations	Furniture proposal	Material proposal
BASIC Free	+	+	Standard	-	-
ADVANCED	+	+	HQ - detailed	+	+



We will send you a short questionnaire to fill out to better determine your needs and preferences. You will have to provide a floor plan with images of your space.

If you have a logo and brand guidelines, please do include them as well.



Space characteristics, optimal space fluctuation, functional as well as sales areas including your personal guidelines are all important factors when planning a space. 20+ years of experience allows us to plan and deliver sales efficient, highly functional and aesthetically beautiful interiors for each taste.



Several views of your future shop are translated into realistic 3D visualizations. They help in comprehending the entire space, the displays, furniture and their relations.

Visualisations include:
Displays & furniture layout
Floor design proposal
Wall design proposal
Ceiling design proposal
Lighting design proposal (fixtures)
Furniture proposal
Decors, materials and supplier recommendations (Advanced only)



Proposed furniture is described with images, short description and a supplier suggestion.



Materials and decors are explained with images, text and a supplier suggestion.

PRODUCTION



Located in Zagreb, Croatia, only a half an hour drive from the national airport dr. Franjo Tuđman.

2500 m2 large production halls.

35 employees working closely with our designers and engineers.

Shipping world wide.

Materials used in our production are mainly aluminium, acrylic, glass and MDF which is prepared by our cooperators but finished inhouse. Technology processes in our production include CNC and laser cutting, plastic molding, spot welding etc.

Beside our standard product lines, we also produce custom products for large companies within industry. Some of the clients we've worked for are: MPG Group, Mokki, Apollo Optik, Optical Centre, Krys, Optic 2000.

Lighting proposal

Pre-Installation instructions

Electrical plan

Production

Shipping

Installation

—

+

+

+

+

+

+

+

+

+

+

+

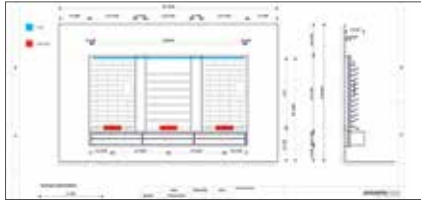

Detailed ambient lighting calculation is made to achieve and provide ideal light distribution throughout your future space. Lighting fixtures and supplier suggestion included.

Front view, floor plan or shop window plan with display exact dimensions and instructions for the successful installation of our displays.

Please be aware that delays and additional fees are to be expected if the space isn't prepared for installation within the agreed dates.

Front view of each wall with exact dimensions, our displays and required electrical sockets.

Production time is 8 – 10 weeks from the confirmed order – for an entire shop.

Shipping type, price and time depends on the location and the product quantity and weight.

Truck transportation

Inside Europe:
4 – 10 working days.

Sea freight

Via Rijeka, Croatia and Bremerhaven, Germany sea ports: 2 – 4 weeks.

Air freight

Outside Europe:
5 – 7 working days.

Express shipping

Small orders only:
1 – 2 working days.

Every product is delivered with assembly instructions. Installation team is available for an additional fee for the installation of an entire shop. If the space is set for installation, the entire shop can be completed within a day.

SHOWROOM



Our newly renovated 220 m2 showroom is located in Mannheim, Germany, only an hour drive from the Frankfurt airport. Located in an up and coming design district, a former industrial area, it is surrounded with many design businesses and popular venues.

Start your project in a creative and inspirational atmosphere! Explore the variety of our displays and their unique features at first hand.



Presenta Nova GmbH

Industriestraße 35
D-68169 Mannheim
+49 621 7245 0040

info@presenta-nova.de
www.presenta-nova.com
@presenta.nova

Opening hours

Monday – Friday
09.00 – 17.00

WS.2024

SHOWROOM
Presenta Nova GmbH
Industriestraße 17
D-68169
Mannheim
+49 621 7245 0040
info@presenta-nova.de

HQ & PRODUCTION
Presenta Nova d.o.o.
Puzeva 7
HR-10020
Zagreb
+385 1 6524 048
info@presenta-nova.hr

www.presenta-nova.com